

**CASTLE** Series

RACK 1-3K(S) UPS

**USER MANUAL**







Thank you for selecting a SANTAK product to protect your electrical equipment.

This manual contains important instructions that you should follow during installation and maintenance of the UPS and batteries. Please read all instructions before operating the equipment and save this manual for future reference.

## Solemn Declaration

### SICPA PRODUCT SECURITY

In order to ensure the safety of your electricity and help you purchase the real Santak UPS, please pay attention to the following items:

1. Santak registered trademark:  **SANTAK** 、  山特 、  山特 ；
2. Santak Electronics (Shenzhen) Co., Ltd. has never authorized any other company to produce UPS in any form in China;
3. All frame of Santak products are labeled "product serial number" (product serial number is unique, a product corresponds to a serial number);
4. Consumers can identify the authenticity of the product through the following channels。

### Copyright Notice

Santak company is committed to technological innovation, and constantly provide better products and services to meet customer needs, product design, technical specifications. Correct specifications depend on the actual model all specifications are subject to change without prior notice. Please download the latest version of the product manual at the Santak website [www.santak.com](http://www.santak.com).

## Safety Instructions

**Please read carefully the following user manual and the safety instructions before installing or operating the unit!**

### Operation Safety

1. Please read all instructions before operating the equipment and connecting to mains power, save this manual for future reference.
2. Please pay attention to all the warning indication, understand and follow all the instruction.
3. Do not install the UPS where it would be exposed to direct sunlight , Rain or damp environment.
4. Do not install the UPS near to heating equipment or heating source and heating environment.
5. Do not block ventilation openings on the UPS's housing. Ensure the air vents on the front, side and rear of the UPS are not blocked. Recommended at least 50cm of space on each side.
6. Use dry cloth for cleaning.
7. Use dry-chemical fire extinguisher when UPS present fire danger, do not use fluid-fire extinguisher, fluid- fire extinguisher will cause hazards shock.
8. In order to reduce the interference of UPS, the output line length of UPS should be within 10 meters.
9. For pluggable devices, sockets shall be installed near the equipment and shall be accessible.

## **Electricity Safety**

Do not remove the enclosure. This system is to be serviced by qualified service person only. There are NO USER SERVICEABLE PARTS inside the UPS.

1. Assure UPS is reliably connected to earth properly, verify connecting wire and battery polarity is correct before turn on UPS with mains power.
2. If UPS requests moving to another place or reconnecting power wire, it is imperative to disconnect all the power connections of UPS, and turn off UPS.
3. Please used the UPS accessories specified by SANTAK.
4. Shock Risk.

If equipment powered by UPS require any type of maintenance, it is imperative to disconnect it from UPS before maintenance.

If input or output terminal need any maintenance or installation, it is imperative to disconnect all the power connections of UPS and turn UPS off.

## **BATTERY SAFETY**

1. The service lifetime of UPS battery depends on ambient temperature, high ambient temperature will impact the service lifetime of UPS battery. Replace battery on regularly can help to keep UPS running efficiently and provide backup time as expected.
2. Batteries must be maintained and replaced only by qualified person.
3. Batteries have a high short-circuited current and pose a risk of shock. Take all precautionary measures specified below and any other measures necessary when working with batteries:
  - A. Remove all jewellery, wristwatches, rings and other metal objects.

- B. Use only tools with insulated grips and handles.
  - C. Wear rubber gloves and boots.
  - D. Do not lay tools or metal parts on top of batteries.
  - E. Disconnect the charging source prior to connecting or disconnecting battery terminals.
4. Do not attempt to dispose of batteries by burning them. It could cause explosion.
  5. Do not open or destroy batteries. Effluent electrolyte can cause injury to the skin and eyes. It may be toxic. If cause injury by Effluent electrolyte, use cool water for washing and go to hospital ask for help immediately.
  6. Do not short the battery with metal objects, It could cause an electric shock, fire or explosion.

## **Maintenance**

1. The operation environment and store environment will impact on the service lifetime and reliability of UPS.

Do not install or store the UPS in the places where are listed below.

- A. Do not install UPS in place where the ambient temperature lower than 0°C or higher than 40°C.
  - B. Do not install/store UPS in place where the relative humidity lower than 20% or higher than 90%.
  - C. Do not install/store UPS in place where there is flammable or corrosive gas, place with large amounts of conductive dust, place exposed to shock or vibration, or outdoor.
2. If you would store the UPS for a long period, the storing area temperature should be the range of -25°C to 55°C, and before turning on UPS, it is highly suggested to put UPS in the ambient temperature above 0°C and last at least 2 hours.

# CONTENT

<b>SOLEMN DECLARATION</b> .....	<b>- 2 -</b>
<b>1. INTRODUCTION</b> .....	<b>- 7 -</b>
1.1 Introduction.....	- 7 -
1.2 Description of Commonly Used Symbols .....	- 8 -
1.3 Safety Instructions.....	- 9 -
1.4 Features .....	- 10 -
1.5 Product Specification.....	- 14 -
<b>2. INSTALL</b> .....	<b>- 17 -</b>
2.1 Unpacking and Check .....	- 17 -
2.2 Rack1K(S)/Rack2K(S)/Rack3K(S)install.....	- 17 -
<b>3. OPERATION</b> .....	<b>- 20 -</b>
3.1 Panel Description .....	- 20 -
3.2 Operation mode.....	- 22 -
3.3 Operation.....	- 25 -
3.4 Communication interface .....	- 29 -
<b>4. MAINTENANCE</b> .....	<b>- 30 -</b>
<b>5. TROUBLE SHOOTING</b> .....	<b>- 31 -</b>



# 1. Introduction

## 1.1 Introduction

This On-Line-Series is an uninterruptible power supply incorporating double-converter technology. It provides perfect protection specifically for Novell, Windows NT and UNIX servers.

The double-converter principle eliminates all mains power disturbances. A rectifier converts the alternating current from the socket outlet to direct current. This direct current charges the batteries and powers the inverter. On the basis of this DC voltage, the inverter generates a sinusoidal AC voltage, which permanently supplies the loads.

Computers and periphery are thus powered entirely by the mains voltage. In the event of power failure, the maintenance-free batteries power the inverter.

This manual covers the UPS listed as follows. Please confirm whether it is the model you intend to purchase by performing a visual inspection of the Model No. on the rear panel of the UPS.

Model No.	Type	Model No.	Type
Rack 1K	Standard	Rack 1KS	Extended backup time
Rack 2K		Rack 2KS	
Rack 3K		Rack 3KS	





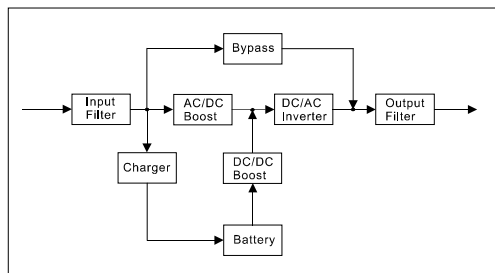







“S” Model: Extended backup time

UPS System Diagram:



## 1.2 Description of Commonly Used Symbols

Some or all of the following symbols may be used in this manual. It is advisable to familiarize yourself with them and understand their meaning:

Symbol and Explanation			
Symbol	Explanation	Symbol	Explanation
	Alert you to pay special attention		Protective ground
	Caution of high voltage		Alarm silence
	Turn on the UPS		Overload indication
	Turn off the UPS		Battery
	Idle or shut down the UPS		Recycle
	Alternating current source (AC)		Do not dispose with ordinary trash
	Direct current source (DC)		

## 1.3 Safety Instructions

### Safety Rules

Read the safety rules in this manual, which must be strictly observed during the installation, use and maintenance of the UPS.

Note :

- UPS has high pressure inside.
- UPS can supply power by battery, and output may have high voltage even if the input power line is not connected

Battery voltage and external battery box for each model:

Model	Battery voltage	Battery box weight (kg)	Battery box size W × L × H (mm)
			Battery module
Rack1KS	36V	20.0	438*420*87
Rack2KS	72V	20.0	438*420*87
Rack3KS	96V	24.8	438*420*87

- Protective earth wire installation- Yellow/green wire is required, The wire diameter is not less than the following table requirements.

Type	Wire Diameter (≥)
Rack1K(S)	18AWG
Rack2K(S)/ Rack3K(S)	16AWG

- Do not make the battery very short or reverse.
- Please put UPS City electrical outlet in the vicinity of UPS so as to unplug the mains and plug the power supply in emergency case.

### Dangerous Voltage

- Before touching the battery, make sure that there is no high voltage between the battery terminals and the protective ground.
- Avoid electric shocks. The connection of the battery and the machine should be broken before repairing the machine.

## 1.4 Features

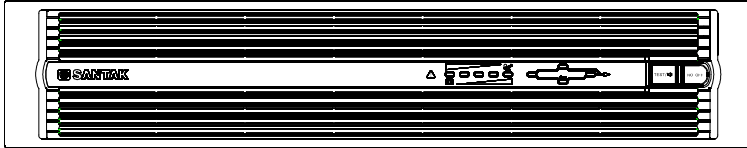

Rack1K(S)/Rack2K(S)/Rack3K(S) Front Panel

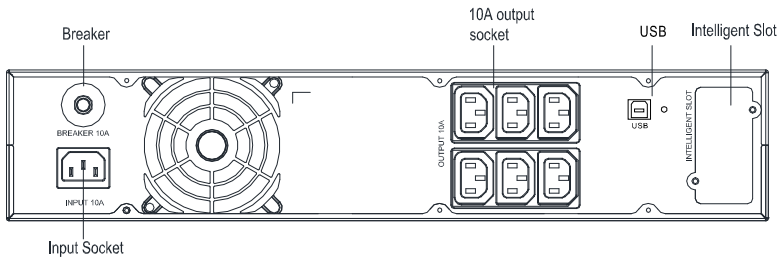

Rack1K Rear Panel

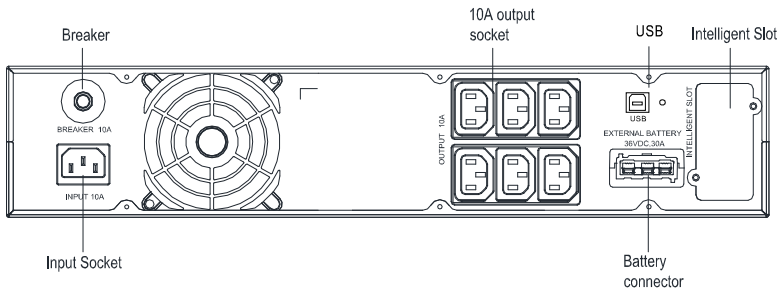

Rack1KS Rear Panel

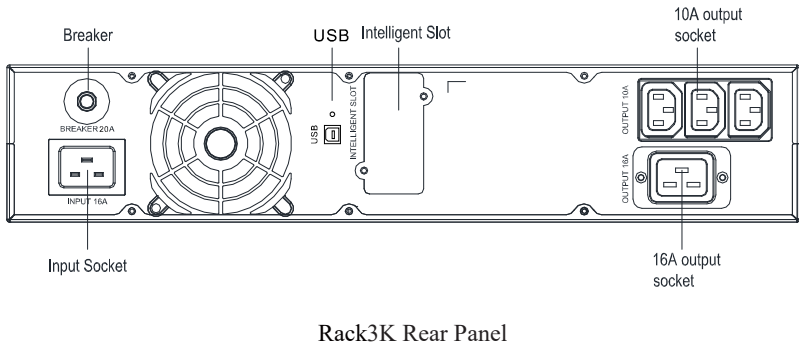
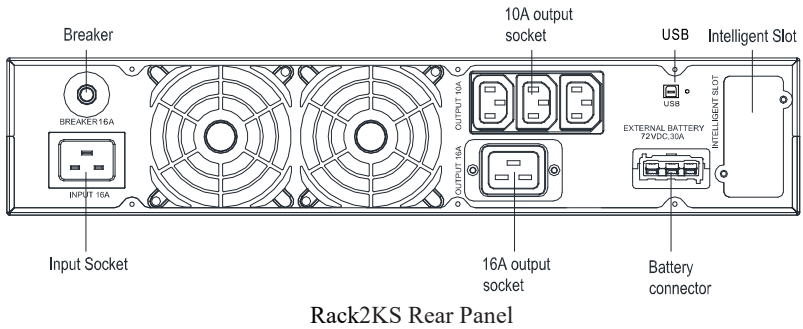
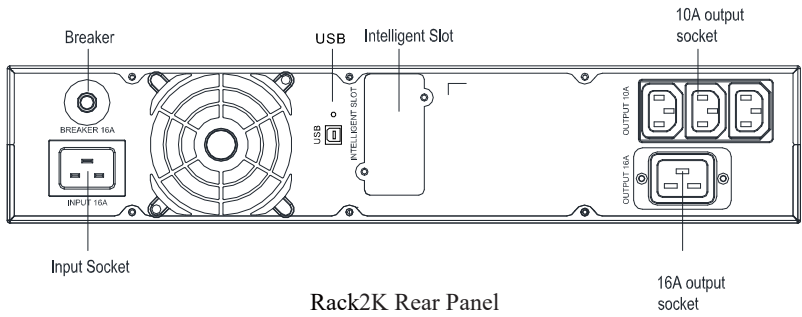

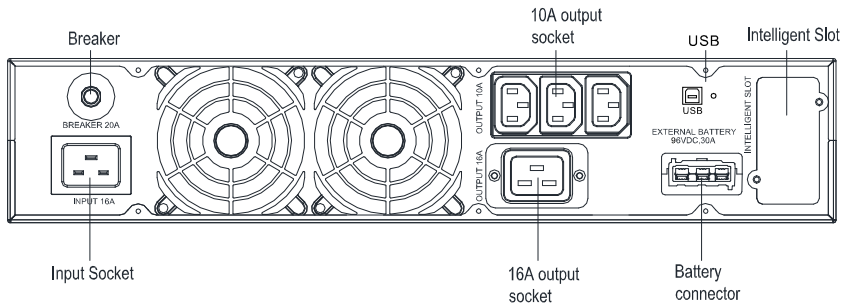

Rack3KS Rear Panel

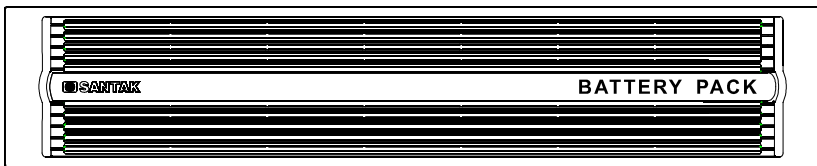

Rack1K(S)/Rack2K(S)/Rack3K(S) EBM Front Panel



Rack1K(S) EBM Rear Panel

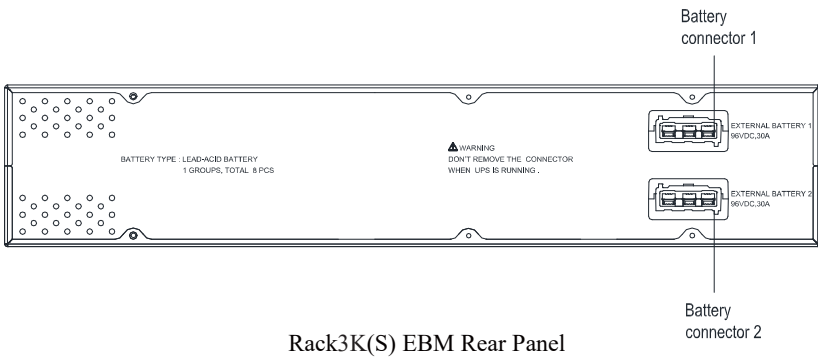
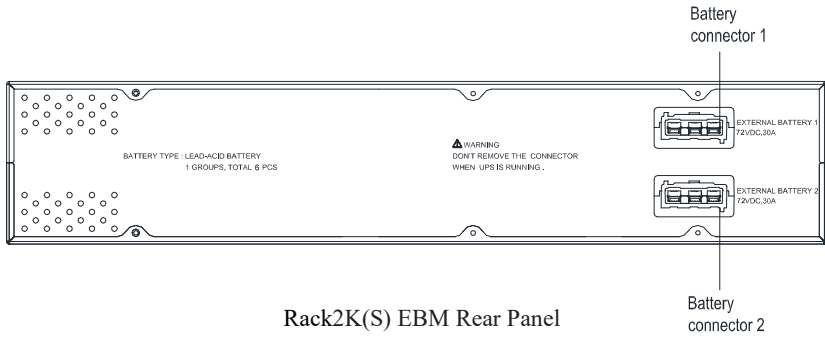

## 1.5 Product Specification

Model	Rack1K	Rack1KS	Rack2K	Rack2KS	Rack3K	Rack3KS
Dimensions W*D*H(mm)	438*420*87		438*570*87	438*420*87	438*570*87	438*420*87
Net Weight(kg)	11.0	7.2	17.5	8.9	21.6	9.0
Power Rating(VA/W)	1KVA/800W(Default)		2KVA/1600W(Default)		3KVA/2400W(Default)	
	1kVA/900W (Ambient temperature < 30°C)		2kVA/1800W (Ambient temperature < 30°C)		3kVA/2700W (Ambient temperature < 30°C)	
<b>Input</b>						
Input mode	Single phase grounding					
Rated voltage	220VAC					
Voltage range	110-300VAC					
Frequency range	40Hz-70Hz					
Power factor	0.98					
Bypass Mode Voltage Range	80VAC×(1±5%) ~ 285VAC×(1±5%) Default 180VAC×(1±5%) ~ 264VAC×(1±5%)					
<b>Output</b>						
Output mode	Single phase grounding					
Rated voltage	220VAC					
Power factor	0.8 (0.9) ①					
THD	±2%					
Frequency range	Line mode	1. When the input frequency is 46-54 Hz, the output is consistent with the input 2. When the input frequency < 46Hz or > 54Hz, the output frequency is locked 50Hz				
	Battery	50 ±0.05 Hz				
Output Overload (Utility mode 25°C)	105%-150% , 47s-25s ; 150%-200% , 25s-300ms ; 200%以上 200ms ( Output factor= 0.8 )					
Switch time	0ms ( Utility mode<—>Battery mode )					
	<4ms ( Utility mode <—> Bypass Mode )					
<b>Battery</b>						
Battery voltage	24VDC	36VDC	48VDC	72VDC	72VDC	96VDC
Battery No.	12VDC×2	12VDC×3	12VDC×4	12VDC×6	12VDC×6	12VDC×8



Backup time (25°C)	PF=0.8      100% load ≥ 3mins
Recharge time	5 hours to 90% (Standard) Depend on external battery capacity ( Time release )

Model	Rack1K	Rack1KS	Rack2K	Rack2KS	Rack3K	Rack3KS
EMC Standard	GB7260.2		IEC 62040-2-2005			
National standard	GB 4943.1-2011		GB 7260.1-2008, EN62040-1			
Industry standard	YD/T 1095-2008		CQC 3108-2011			
Operation	PF=0.8 0°C~40°C		PF=0.9 0°C~30°C			
Store temperature	-25°C~55°C					
Relative humidity	20%~90% (non-condensing)					
Altitude	<1000m					

① When ambient temperature < 30°C, Output power factor can be changed to 0.9 through the serial command, Default power factor is 0.8.

---

**⚠ Note: If the UPS is used above elevation 1000M, the derating rating must be used, and the derating factor is shown in the following table.**

---

High altitude load = Rated power × Derating coefficient (Corresponding to elevation)

Elevation (m)	1000	1500	2000
Derating	100%	95%	91%

## 2. Install

### 2.1 Unpacking and Check

Open the package. Firstly check that whether the appearance of the UPS device is damaged. If damaged, please don't turn on the machine and contact the supplier.

Then check whether the random attachments are completely: a pair of ears, one of power cords, one of manual, one of the battery wires (the standard does not contain) .

### 2.2 Rack1K(S)/Rack2K(S)/Rack3K(S)install

1. Plug the UPS power cord into the appropriate socket which has overcurrent protection, and maintain the socket with sufficient capacity.
2. Rack1K(S) UPS input sockets require more than 10A capacity, Rack2K(S)/Rack3K(S) UPS input sockets require more than 16A capacity.
3. Directly connect the UPS output socket to the load.
4. UPS input and output require ground protection.

Rack1KS/Rack2KS/Rack3KS Battery installation step:

1) Please select the battery voltage and number required by this model; each battery is connected in series with 3 sections for Rack1KS (36VDC), connected in series with 6 sections for Rack2KS (72VDC), connected in series with 8 sections Rack3KS (96VDC).

2) Connect the battery in series, measuring two terminal voltage of battery pack and ensure to meet the above requirements. Connect the red battery line to the battery "+", Connect the black battery line to the battery "-", Yellow / green line to battery box protecting ground wire;

3) After making sure the positive and negative connections are correct, Plug the battery cord into the UPS.

Rack-mount installation:

- 1) Remove screw



- 2) Align the mounting ears with screw holes on the side of the UPS, and tighten the screw. (Pay attention to the installation direction of lug, concave downward)



- 3) Slide in the UPS into the rack rail and lock it in the Rack-mounting , Tighten the screw, and then the load can be connected.

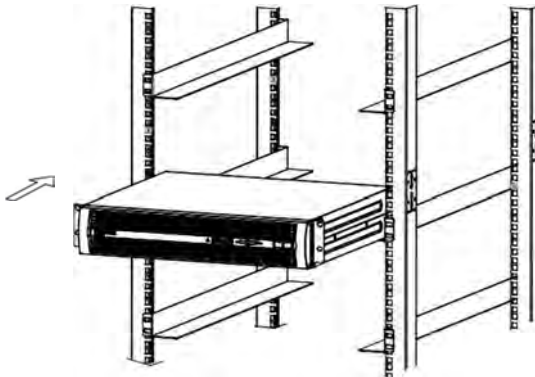

The installation dimensions are as follows:

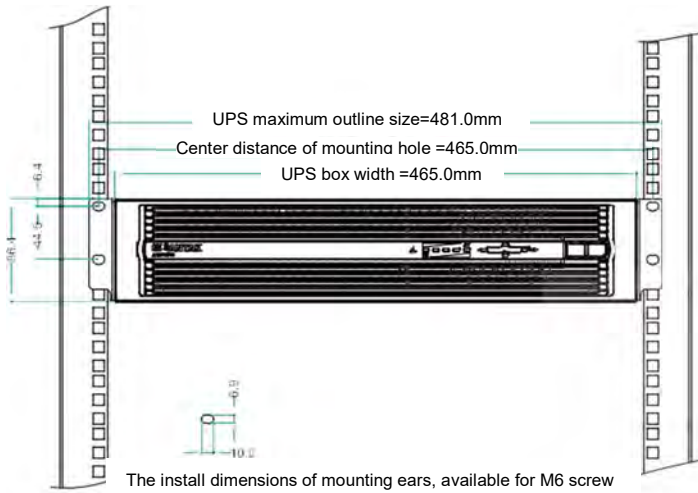

# 3. Operation

## 3.1 Panel Description

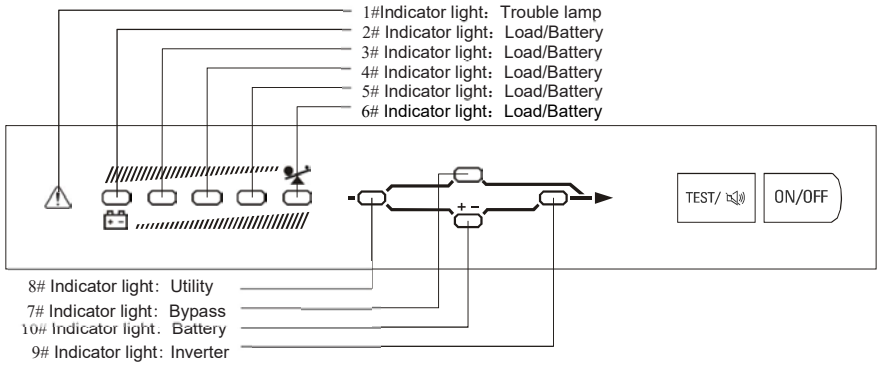

Operation display panel

## 1. **Switch key**

The main functions of the switch keys:

Turn On: Press the switch button, more than 1 seconds to boot. UPS will issue a tweet when the boot is successful.

Turn Off: When the UPS is in the utility mode and battery mode, press the switch button for more than 1 second to turn off the power

Clear fault: Press the switch key for more than 3 seconds to clear the fault state.

## 2. **Function key**

The main function of the function key:

Battery self-test: In the utility mode, press the function key for more than 2 seconds, you can turn on the battery self-test, and operate battery self-test.

Silencing in battery mode: Press the function key for 2 seconds to eliminate the alarm sound in the battery mode, and then continue to press the function key for more than 2 seconds, and the alarm sound is resumed.

Silencing in bypass mode: Press the function key for 2 seconds to eliminate the warning sound in the bypass mode, and then continue to press the function key for more than 2 seconds to restore the alarm sound.

Silencing in all mode: Continue to press the function key for more than 10 seconds to achieve mute function, and then continue to press the function key for more than 10 seconds, the alarm sound recovery. Button tone, battery discharge, cut-off voltage, alarm sound (one second call) are not in the mute range.

## 3. **LED Indicator light**

Include: Fault indicator light, load / battery capacity indicator, bypass indicator light, utility indicator, inverter indicator, battery indicator light.

Indicating meaning of LED indicator light

No.	Name	Colour	Description
1#	Fault indicator light	Red	This light indicates an abnormal

2#	load / battery capacity indicator	Orange	Indication of load capacity or battery capacity: 1. On utility / bypass mode, just indicate load capacity, as load capacity indicator 2.On battery mode, just indicate battery capacity, as battery capacity indicator
3#	load / battery capacity indicator	Green	
4#	load / battery capacity indicator	Green	
5#	load / battery capacity indicator	Green	
6#	load / battery capacity indicator	Green	
7#	Bypass indicator	Orange	The load power is supplied directly from the utility
8#	Utility indicator	Green	The light on indicate UPS is normal
9#	Inverter indicator	Green	The light indicates the power supply or the battery is powered by the
10#	Battery indicator	Orange	This light indicates that the battery power supplies power to the load

### 3.2 Operation mode

The operation modes of UPS can be divided into Utility mode, Battery mode and Bypass mode.

#### 3.2.1 Utility mode

On the utility mode, the utility indicator and the inverter indicator light are on, and the load indicator light is lit according to the capacity of the connection.

1. If utility indicator blinks, it indicates that "L" and "N" don't connect with "G", UPS still work on utility mode; IF battery indicator blinks at the same time, it indicates that the voltage or frequency of the mains exceeds the normal range, UPS has already worked on battery mode.
2. If the load capacity is more than 100%, the buzzer calls half a second. It reminds you that taking too much load. You should remove the unnecessary load one by one until the UPS load is less than 100%.
3. If the battery indicator flashes, it means that the UPS has not received the battery, or the battery voltage is too low. At this point, check whether the battery is connected properly, and press the function button for 2 seconds to the battery



self-check. Make sure the connection is correct. It may be battery fault or aging. Please refer to the sixth chapter troubleshooting table.

---

⚠ NOTE: If the generator is connected, follow the following procedure:

- When the generator is stable, the generator output power will be connected to the UPS input (at this time to determine the UPS is no-load), and then press the boot program to start UPS, UPS start, and then join the load one by one.
- It is recommended to select the generator capacity by two times the capacity of UPS.

---

### 3.2.2 Battery mode

In the battery mode, the battery indicator and the inverter indicator light are on, and if the utility power is abnormal, the utility lights will flash simultaneously. The battery capacity indicator light is lit according to the size of the battery capacity. Notice that the load indicator in the battery mode is indicated as the battery capacity level during the backup time.

1. In battery mode, the alarm will beep every 4 seconds, if continued to press the button for more than 2 seconds, UPS performs the function of silencing, the alarm will not beep, and then continued to press the button for more than 2 seconds, the alarm recovery.
2. When the battery capacity is reduced, light battery capacity indicator number will be reduced, when the battery voltage drops to early warning of potential (at this time to be larger than the spare time of 2 minutes) buzzer once every 1 second, prompting the user the battery capacity is low, should pay close attention to the load operation and removal load one by one.
3. You can check the backup function by not using the UPS bus.

### 3.2.3 Bypass mode

Set the UPS through Win-Power to bypass it. In the bypass mode, the utility indicator and the bypass indicator light are on, and the load indicator light is lit according to the size of the connected load capacity. UPS tweets once every two minutes.

1. If the utility light blinks, the voltage or frequency of the utility voltage exceeds the normal range or the line is wired wrong, or the ground is not grounded.
2. Other indicators take utility mode for reference.

3. UPS has no backup function when working on bypass mode.

## 3.3 Operation

### 3.3.1 Turn on/off operation

#### 1. Turn on

---

⚠ NOTE: Although the battery is full of electricity at the factory, the power will be lost after transportation and storage. It is recommended that the battery should be charged for 10 hours before the first use of the UPS, so as to ensure sufficient spare time. Please refer to chapter fourth for battery charging methods.

Turn on operation is divided into: UPS turn on with utility power and UPS DC turn on without utility power.

---

#### 1) UPS turn on with utility power connecting

Turn on the utility supply, press the on / off button for 1 second or more, and the UPS will turn on. When turning on, the UPS checks itself. At this point, the load / battery capacity indicator light is fully lit, then go out left to right, one by one, and a few seconds later, the inverter indicator light is on, and the UPS is already operating in the utility mode. If the utility power is abnormal, the UPS will operate in battery mode.

#### 2) UPS DC turn on without utility power connecting

When without utility power connecting, press the on / off button for 1 second or more, and the UPS will turn on. During startup, the UPS action is the same as the utility power connecting, but the light is not on and the battery indicator light is on.

#### 2. Turn off

Turn off operation is divided into: Utility mode, Battery mode

#### 1) UPS turn off in utility mode

Press the on / off button for more than 1s, and UPS will turn off. If the Win-Power set UPS shutdown on inverter mode and change to standby mode, UPS has no output voltage, if utility normally connected, utility lights on, if the utility disconnected for 10s, the load / battery capacity indicator on panel light on all and then finally extinguished, then panel has no display, UPS has no output voltage.

#### 2) UPS turn off on battery mode

Press the on / off button for more than 1s, and UPS will turn off. When turning off, UPS

will start self-check. Then the load / battery capacity indicator on panel light on all and then finally extinguished, then panel has no display, UPS has no output voltage.

### 3.3.2 Battery self-check operation

During UPS operating, the user can manually check the battery status by battery self-check. The method of starting self-check is below:

#### 1. By function keys

In utility mode, press the function key for more than 2s, until hear the buzzer "beep" a sound, 7# ~ 10# indicator light cycle flashing, UPS change to battery mode, then start battery self-check. Battery self-check default duration is 10s (user can also be set via Win-Power). During battery self-check, UPS will switch to utility mode automatically if battery fault occurs.

#### 2. By background monitoring software

Users can also start monitoring the battery through the background monitoring software.

### 3.3.3 LED Display and Alarm

NO	Working Condition		Panel Light Display										
			1#	2#	3#	4#	5#	6#	7#	8#	9#	10#	
1	Utility mode	0%--35% Load						●		●	●		No
2		36%--55% Load					●	●		●	●		No
3		56%--75% Load				●	●	●		●	●		No
4		76%--95% Load			●	●	●	●		●	●		No
5		96%--105% Load		●	●	●	●	●		●	●		No
6	Battery mode	0%--25% Load		●							●	●	1 beep per sec
7		26%--50% Load		●	●						●	●	1 beep every 4sec
8		51%--75% Load		●	●	●					●	●	1 beep every 4sec
9		76%--95% Load		●	●	●	●				●	●	1 beep every 4sec
10		95% Load		●	●	●	●	●			●	●	1 beep every 4sec
11	Bypass mode			↑	↑	↑	↑	●	●	●			1 beep every 2 mins
12	Over load in utility mode, change to bypass mode		●	●	●	●	●	●	●	●			continuously beep
13	Utility abnormal			↑	↑	↑	↑	●	↑	★	↑	↑	↑
14	Over load in battery mode, early warning		●	↑	↑	↑	↑	↑			●	●	2 beep per sec
15	Over load in utility mode, early warning			●	●	●	●	●			●	●	2 beep per sec
16	Over load in battery mode, cut output		●	●									continuously beep
17	Over temperature		●					●	↑	↑			continuously beep
18	Inverter abnormal		●				●		↑	↑			continuously beep
19	BUS short-circuited		●			●			↑	↑			continuously beep
20	BUS high voltage		●			●		●	↑	↑			continuously beep
21	BUS low voltage		●			●	●	●	↑	↑			continuously beep
22	BUS soft start timeout		●	●		●	●	●	↑	↑			continuously beep
23	Utility input Fuse/NTC/ Rectifier open circuit		●			●	●						continuously beep
24	The charger output voltage is too high		●		●				↑	↑			continuously beep
25	Battery voltage abnormal		↑	↑	↑	↑		↑			★	↑	↑
26	Utility input reversed or unconcerned ground			↑	↑	↑	↑	●	↑	★	↑	↑	1 beep every 2 mins

27	Charge board or battery break	●						↑	↑	★	continuously beep
28	Output short-circuited	●	●			●		↑			continuously beep
29	Fan working abnormal	●	●				●	↑	↑	↑	1 beep per sec
30	Inverter capacitor open circuit	●	●	●	●	●		↑	↑		continuously beep

Light indication:

●: light on ★: light flashing †: Depends on other states

### 3.4 Communication interface

This series of UPS provides USB, intelligent slot communication interface. Intelligent slot have this optional: Webpower card, AS400 card, CMC card, to achieve remote monitoring and management.

Explanation:

1. Intelligent slot and optional Webpower card, AS400 card, CMC card are optional.
2. Downloadable graphical WinPower monitoring software and USB drivers are available free of charge from SANTAK web site.

---

**⚠NOTE:** USB line shall not be parallel with the input and output lines to prevent interference.

It is recommended to use shielded USB lines no more than 3 meters.

---

Description of the foot of AS400 communication port:

Pin#	Description	I/O
1	UPS Fail	Output
2	Summary Alarm	Output
3	GND	Input
4	Remote Shutdown	Input
5	Common	Input
6	Bypass	Output
7	Battery Low	Output
8	UPS ON	Output
9	Line Loss	Output

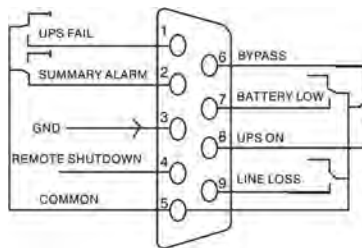

AS400 Communication interface

## 4. Maintenance

- This series UPS only requires minimal maintenance. The battery used for standard models are value regulated sealed lead-acid maintenance free battery. These models require minimal repairs. The only requirement is to charge the UPS regularly in order to maximize the expected life of the battery. When being connected to the mains power, whether the UPS is turned on or not, the UPS keeps charging the batteries and also offers the protective function of overcharging and over-discharging.
- The UPS should be charged once every 4 to 6 months if it has not been used for a long time.
- If the battery is found not in good condition, replacement should be made. Battery replacement should be performed by qualified person.
- When replacing batteries, replace with the same type and number of batteries or battery packs. Contact your service representative to order new batteries.
- Do not replace the battery individually. All the batteries should be replaced at the same time following the instructions of the battery supplier.
- Normally, the batteries should be charged and discharged once every 4 to 6 months. Charging should begin after the UPS shuts down automatically in the course of discharging, the standard charging time for the standard UPS should be at least 12 hours.
- In the regions of hot climates, the battery should be charged and discharged every 2 months. The standard charging time should be at least 12 hours.
- If UPS is intend to be used in a no-people environment for a long time, need to inspect whether battery is normal in circularly to avoid battery damage caused by over-discharge.



## 5. Trouble shooting

 NOTE: If the UPS does not operate correctly, please press the "switch machine" button for a long time to clear the trouble, prevent the battery from long-term discharge damage, forbid to turn on the machine again, so as to avoid greater damage to the machine.

UPS fault handle list

Warning & Fault Code	Possible cause	Method
1 # Fault indicator and 6 # light on, buzzer beeps continuously	UPS shut down due to internal overheating	Ensure that the UPS is not overloaded, the vents are not plugged, the room temperature is not too high, wait 10 minutes for UPS to cool, and then restart. If failure, please contact your supplier
1 # Fault indicator and 5 # light on, buzzer beeps continuously	UPS shut down due to internal faults	please contact your supplier
1 # Fault indicator and 4 # light on, buzzer beeps continuously	UPS shut down due to internal faults	please contact your supplier
1#, 4#, 5# Fault indicator light on, buzzer beeps continuously	UPS shut down due to internal faults	please contact your supplier
1#, 2#, 3#, 4#, 5# Fault indicator light on, buzzer beeps continuously	UPS shut down due to internal faults	please contact your supplier

1 # Fault indicator and 3# light on, buzzer beeps continuously	UPS overcharge protection action	UPS charger fault, please contact your supplier
8# utility indicator flashing	The utility voltage or frequency is beyond the UPS input range	UPS is working in the battery mode, saving data and closing the application to ensure that the utility is in the input voltage or frequency range that UPS allows
	Utility input reversed, 1 beep every 2mins for UPS	Reconnect the utility line to correct
	“Freerun” or “Converter” Overload to battery, 1sec flashing, battery light is normal	please contact your supplier
1 # Fault indicator and 2# light on, buzzer beeps continuously	UPS overload in battery mode or Load equipment failure	Check the load levels and remove non critical devices, recalculate load power, and reduce the amount of load connected to the UPS, and check if the load device is faulty
1 # Fault indicator and 2# 、 6# light on, buzzer beeps per sec	UPS fan unconnected or fan damaged	please contact your supplier
1 # Fault indicator and 2# 、 5# light on, buzzer beeps continuously	UPS output short-circuited	Turn off the UPS, remove all the load, confirm the load is not fault (manually except for the fault, long press the switch button for 3 seconds) or internal short circuit, restart, if fail, please contact your

<b>Warning &amp; Fault</b>	<b>Possible cause</b>	<b>Method</b>
10 # battery light flashing	The battery voltage is too low or the battery is not connected	Check the UPS battery section and connect the battery. Contact your supplier if the battery is damaged
1 # Fault light on, 10 # battery light flashing, buzzer beeps continuously	UPS charging fault	please contact your supplier
Utility normally, UPS without utility connection	UPS input circuit breaker is disconnected	Manually reset the circuit breaker
Battery discharge time is short	Battery is under charged	Maintain the UPS and continue to connect the utility for more than 10 hours, recharging the battery
	UPS overload	Check load levels and remove non critical devices
	Battery aging, capacity degradation	Replace the battery, please contact your supplier to obtain the battery and its components
The UPS cannot start after the power button is pressed	Press the turn on button time is too short	Press the boot button for more than 1 sec to turn on UPS
	UPS not connected to battery or battery on low voltage and loaded with power on	Connect the UPS battery. If the battery voltage is low, turn off the power before starting the UPS
	An internal fault occurred inside the UPS	Please contact your supplier



**SANTAK ELECTRONIC (SHENZHEN) CO.,LTD**

---

No.8 Baoshi Rd, Block 72 Baoan, Shenzhen,  
Guangdong, China

[www.santak.com](http://www.santak.com)